

TOSHIBA

Leading Innovation >>>

Industrial Camera Systems

CCD MICRO CAMERA series

REMOTE HEAD CCD CAMERA SYSTEM



control unit
IK-CU51



17mm 1-CCD
IK-M51H

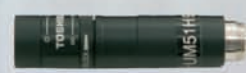

12mm 1-CCD
IK-UM51H



SYSTEM COMPONENTS

IK-CU51 (PAL) and IK-CU44 (NTSC)

Lenses



Camera heads



Cables



Control units



Power supply



PIN ASSIGNMENTS

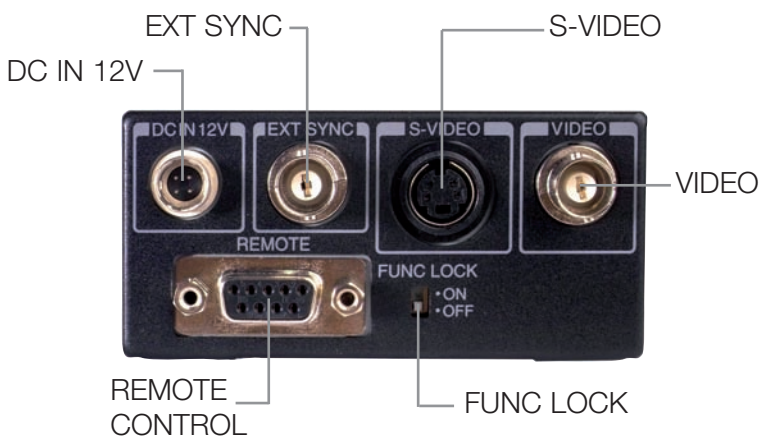

DC IN 12V	
1	+12V
2	+12V
3	GND
4	GND

S-VIDEO	
1	+12V
2	+12V
3	Y
4	C

REMOTE	
1	NC
2	TXD
3	RXD
4	DSR
5	GND
6	DTR
7	CTS
8	RTS
9	NC

EXTERIOR DIMENSIONS

Camera control unit
IK-CU51

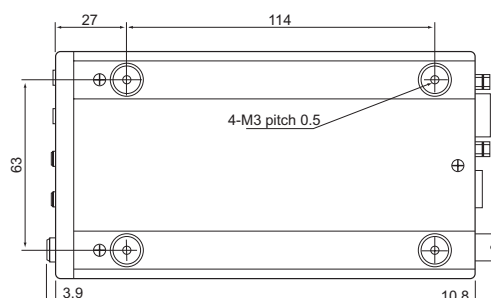
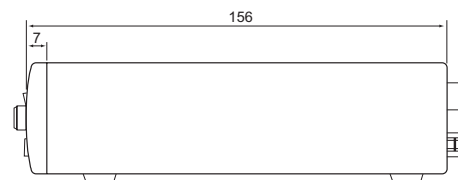
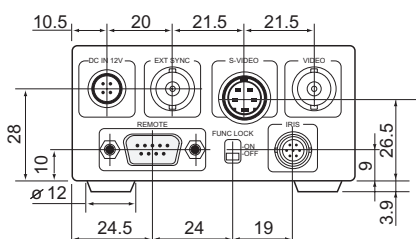
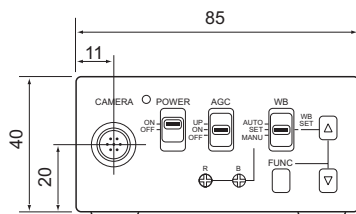

Camera head 1/3"
IK-UM51H

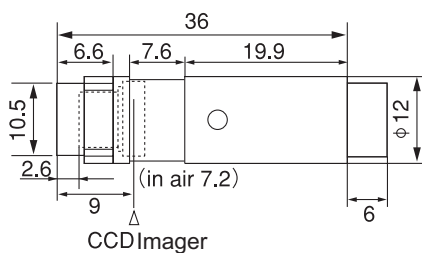

Camera head 1/2"
IK-M51H

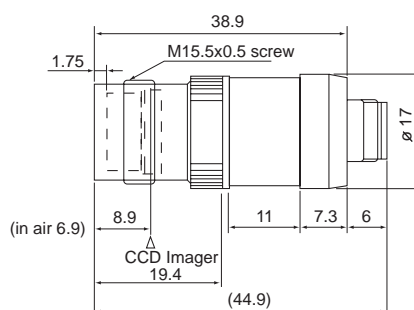

ACCESSORIES



Lens IK-UM51H		
Type name	Focal length mm	F stop
JKL-03U	3.0	2.0
JKL-55U	5.5	1.6
JKL-11U	11.0	2.0
JKL-18U	18.0	3.3



Lens IK-M51H		
Type name	Focal length mm	F stop
JKL-03M	3.0	1.8
JKL-04M2	4.5	2.0
JKL-7.5M	7.5	1.6
JKL-15M	15.0	2.0
JKL-24M2	24.0	3.1

Camera cables IK-UM51H & IK-M51H

Type name	Nominal length m	diameter mm
EXC-4302	2	5.0
EXC-4303	3	5.0
EXC-4305	5	5.0
EXC-4312	12	5.0
EXC-4320	20	5.0
EXC-4330	30*	5.0
EXC-4354	54*	5.0

* only IK-M51H

AC-M601E - Medical approved



SPECIFICATIONS

Power supply	DC12V +/-0.5V (AC-M601E) Medical app.
Power consumption	360 mA
Image sensor	1/2" (IK-M51H), 1/3" (IK-UM51H)
Effective pixels	Horizontal: 752 Pixels, Vertical: 582 Pixels
Effective image area	Horizontal: 6.47mm, Vertical: 4.83mm (1/2 inch type) Horizontal: 4.89mm, Vertical: 3.64mm (1/3 inch type)
Scanning system	2:1 interlace
Scan frequency	Horizontal: 15.625 kHz, Vertical: 50Hz
Sync system	Internal/External (automatic switching)
Resolution	Horizontal: More than 470 lines, Vertical: More than 420 lines
Standard intensity of illumination for objects	30 lx (F1.6, 3000K)
Minimum intensity of illumination for objects	2.5lx (F1.6, 3000K)
S/N ratio	46 dB or more
Video output	VBS 1.0 V (p-p), (BNC terminal) PAL System Y/C separation output (S terminal)
Output impedance	75 Ohm unbalanced
External Sync Input	VBS 1.0 V (p-p), (BNC terminal) PAL 75 Ohm unbalanced
Adjustment function	Subcarrier phase, H phase
White balance	Automatic / set / manual
Gain switch (AGC)	SENS UP (+6 dB) /ON/OFF
Electronic shutter	Automatic, 1/50s, 1/100s, 1/250s, 1/500s, 1/1000s, 1/2000s, 1/4000s, 1/10000s, synchronized scan
Operating temperature/ humidity	14°F to 104°F (-10° C to +40° C) / Less than 90%
Anti-vibration/ shock characteristics	70 m/s ² (10 to 200 Hz) / 700 m/s ²
Weight	Control unit: 0.86lbs (390g)
(Dimensions) (Without protrusion)	Control unit: W: 3.35", H: 1.57", D: 6.14" (W: 85mm, H: 40mm, D: 156mm)
	NTSC standard also available Design and specifications are subject to change without notice

TOSHIBA Europe GmbH
Chriesbaumstrasse 4
CH-8604 Volketswil
Switzerland

www.toshiba.ch/ics
professional@toshiba.ch
Tel: +41 (0)44 908 56 30
Fax: +41 (0)44 908 56 57

Distributor: